

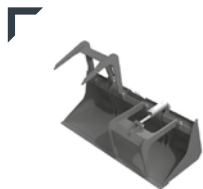

GREEN LINE PI PH PA FA GRAPPLES

PI - INDUSTRIAL GRAPPLE

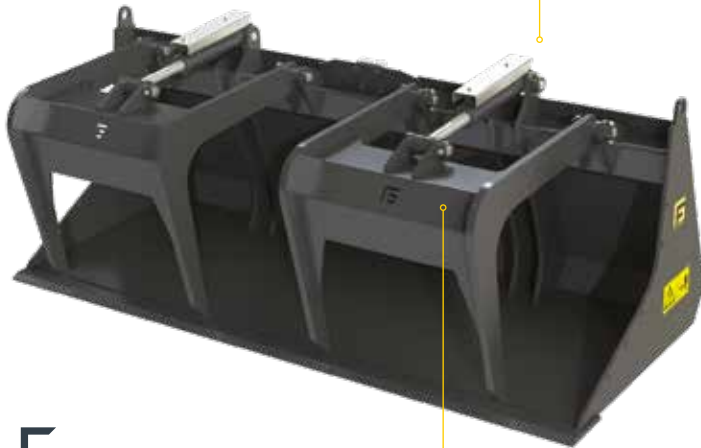

UPPER BITES

independently operable from each other by two cylinders hydraulic to retain the materials heavier during the transport

PH - HEAVY DUTY GRAPPLE



PA - FARM GRAPPLE

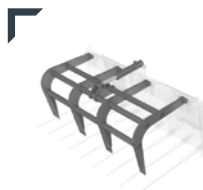

UPPER BITES

independently operable from each other by two cylinders hydraulic to retain the materials heavier during the transport

FA - FARM FORK

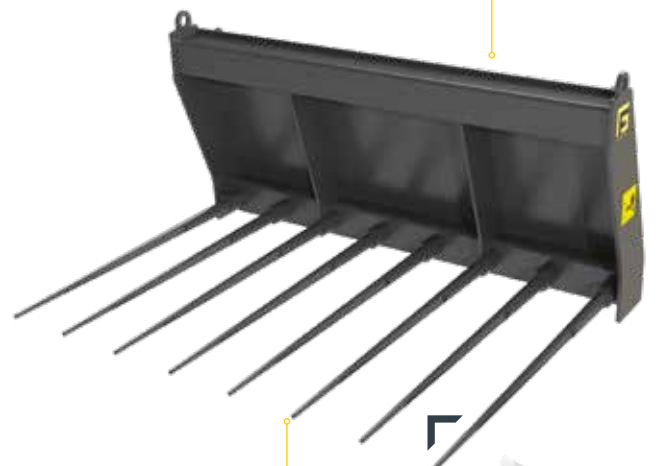

REMOVABLE LOWER TIPS

for collecting agricultural material





The range of GF front grippers and forks is used for **waste or recycling material collection, agricultural material collection, moving building materials** or other. There are 4 available models: industrial grapple, farm grapple, farm

fork and heavy duty grapple.

All models are made with a **robust structure**, so that they can withstand any type of stress and can ensure **excellent durability** over time.



PH	Heavy Duty Grapple	Model	PH 140	PH 155	PH 168	PH 185	PH 205
PI	Industrial Grapple	Model	PI 140	PI 155	PI 168	PI 185	PI 205

Technical data	um					
Working width	mm	1400	1550	1680	1850	2050
Upper spikes	n.	4				
Upper grapples for mod. PH	n.	9	10	11	12	14
Lower spikes width for mod. PH	mm	800				
Weight standard configuration for mod. PH	kg	370	400	430	490	580
Weight standard configuration for mod. PI	kg	275	300	320	350	495
	ton	1,9-2,5	2,2-2,8	2,6-3,6	3,4-4,2	4,0-4,8
	ton	2,3-3,2	2,8-3,6	3,4-4,6	4,4-5,6	5,0-7,5
	ton	2,8-3,4	3,0-3,8	3,6-5,2	5,0-6,0	5,8-6,6
	ton	-	-	-	4,0-5,0	4,8-6,0

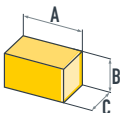
	Overall size in standard configuration	A cm B cm C cm	140 73 PI-79 / PH-86	155 73 PI-79 / PH-86	168 73 PI-79 / PH-86	185 73 PI-79 / PH-86	205 87 PI-90 / PH-88
-------------------------------------------------------------------------------------	----------------------------------------	----------------------	----------------------------	----------------------------	----------------------------	----------------------------	----------------------------

PA	Farm Gapple	Model	PA 125	PA 140	PA 155	PA 168	PA 185
FA	Farm Fork	Model	FA 125	FA 140	FA 155	FA 168	FA 185

Technical data	um					
Working width	mm	1250	1400	1550	1680	1850
Upper grapples for mod. PA	n.	4				
Lower spikes	n.	8	9	10		11
Lower spikes width	mm	800				
Weight standard configuration for mod. PA	kg	195	220	240	260	285
Weight standard configuration for mod. FA	kg	135	155	170	185	200
	ton	1,3-1,8	1,7-2,4	2,0-2,6	2,2-3,0	2,4-3,5

	Overall size in standard configuration	A cm B cm C cm	125 PA-74 / FA-61 90	140 PA-74 / FA-61 90	155 PA-74 / FA-61 90	168 PA-74 / FA-61 90	185 PA-74 / FA-61 90
-------------------------------------------------------------------------------------	----------------------------------------	----------------------	----------------------------	----------------------------	----------------------------	----------------------------	----------------------------